



Meaningful Innovation.

WEEE Number: 80133970

INSTRUCTION MANUAL WALL MOUNTING BATTERY



MODEL	SKU
VT-12040	11447
VT-5139	11448

05 YEAR
WARRANTY*

INTRODUCTION

Thank you for selecting and buying V-TAC Product. V-TAC will serve you the best. Please read these instructions carefully & keep this user manual handy for future reference. If you have any other query, please contact our dealer or local vendor from whom you have purchased the product. They are trained and ready to serve you at the best.



MULTI-LANGUAGE MANUAL QR CODE

Please scan the QR code to access the manual in multiple languages.

IN CASE OF ANY QUERY/ISSUE WITH THE PRODUCT, PLEASE REACH OUT TO US AT: SUPPORT@V-TAC.EU
FOR MORE PRODUCTS RANGE, INQUIRY PLEASE CONTACT OUR DISTRIBUTOR OR NEAREST DEALERS.
V-TAC EUROPE LTD. BULGARIA, PLOVDIV 4000, BUL.L.KARAVELOW 9B

Preface

Thank you for selecting and purchasing V-TAC product. V-TAC will provide you the best service. Please read this instruction carefully & keep this user manual handy for future reference. If you have any another query, please contact our dealer or local vendor from whom you have purchased the product.

In case of any query / issue with the product ,please contact us at :support@v-tac.eu , For more products range and inquiry ,please contact our distributors or nearest dealers V-TAC EUROPE LTD, Bulgaria ,Plovdiv 4000, Bul.I.Karavelow 9B

This document mainly introduces the product introduction,application scenario, installation,commissioning,system maintenance and technical data of household energy storage battery .





Reader object:

This document is mainly applicable to the following Engineers:

- ◆ Marketing Engineer
- ◆ System Engineer
- ◆ Technical support engineer

Symbolic Covention:

The following symbols may appear in this article, and they represent the following meanings:

Symbol	Explanation
 DANGER	Indicates a hazard with high risk that will lead to death or serious injury if not avoided.
 Warning	Indicates a hazard with medium risk that may lead to death or serious injury if not avoided.
 Attention	Indicates a hazard with low-level risk that may cause slight or moderate injury if not avoided.
 Notice	It is used to transmit equipment or environmental safety warning information. If not avoided, it may lead to equipment damage, data loss, equipment performance degradation or other unpredictable results. The "instructions" do not involve personal injury.
 Explanation	Indicates a hazard with high risk that will lead to death or serious injury if not avoided.

Warning:

- 1.Please make sure to turn off the power before starting the installation.
- 2.Installation must be performed by a qualified electrician.



This marking indicates that this product should not be disposed of with other household wastes.

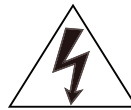

Caution, risk of electric shock.

RoHS



Content

1.Safety precautions	
1.1 General security.....	1-3
1.2 Personnel requirements.....	4
1.3 Electrical safety.....	4
2.Product Introduction	
2.1 Product function and technical specification.....	5-6
2.2 Appearance description.....	7-10
2.3 System diagram.....	11
2.4 System sleep and wake up.....	11
3.Product Installation	
3.1 Unpacking inspection.....	12
3.2 Basic installation requirements.....	13
3.3 Ladder use safety.....	14
3.4 Drilling safety.....	14
3.5 Safety of handing heavy objects.....	14
3.6 Installation guide lines.....	14
4.System connection	
4.1 Communication line	15
4.2 System connection diagram	15
4.3 Battery connection.....	16-17
5.Indicators description.....	18
6.Bluetooth App interface and operation steps.....	19
7.Maintaince and replacemment.....	20
8.Battery storage requirement.....	20

1. Safety precautions

1.1 General security

Statement

When installing, operating and maintaining the equipment, please read this manual first and follow the signs on the equipment and all safety precautions .

The "notice", "attention", "warning" and "danger" in the manual do not represent all safety precautions to be observed, but only supplement all safety precautions. The company shall not be liable for any violation of general safety operation requirements or safety standards for design, production and use of equipment.

The equipment shall be used in an environment that meets the requirements of design specifications, otherwise it may cause equipment failure, and the resulting equipment function abnormalities or component damage, personal safety accidents, property losses, etc. are not within the scope of equipment quality assurance. The installation, operation and maintenance of the equipment shall comply with local laws, regulations and specifications. The safety precautions in the manual are only a supplement to local laws, regulations and specifications.

The company shall not be liable for any of the following circumstances.

- ◆ Do not operate under the service conditions described in this manual.
- ◆ The installation and use environment exceeds the provisions of relevant international or national standards.
- ◆ Disassemble, change the product or modify the software code without authorization.
- ◆ Failure to follow the operation instructions and safety warnings in the product and documents.
- ◆ Transportation damage caused by customer's own transportation.
- ◆ Damage caused by storage conditions not meeting the requirements of product documents.

General requirements

DANGER

Live operation is strictly prohibited during installation.

- ◆ It is strictly prohibited to install, use and operate outdoor equipment and cables (including but not limited to handling equipment, operating equipment and cables, plug and unplug signal interfaces connected to outdoor, high-altitude operation, outdoor installation, etc.) in severe weather such as lightning, rain, snow and force gale.
- ◆ After installing the equipment, the empty packaging materials such as cartons, foam, plastic, tie line should be removed.
- ◆ In case of fire, evacuate the building or equipment area and press the fire alarm bell or dial the fire alarm telephone. Under no circumstances shall re-enter the burning building.
- ◆ It is strictly prohibited to artificially alter, damage or block the identification and nameplate on the equipment.

- ◆ When installing the equipment, use tools to tighten the screws.
- ◆ Paint scratches during equipment transportation and installation must be repaired in time. It is strictly prohibited to expose the scratched parts to the outdoor environment for a long time.
- ◆ Do not open the main panel of the device without the permission of the manufacturer.
- ◆ In any case, do not change the structure and installation sequence of the equipment without the permission of the manufacturer.
- ◆ It is forbidden to affect the battery terminal components during handling, and it is not allowed to lift and handle through the battery terminal bolts.
- ◆ It is not allowed to reverse engineer, decompile, disassemble, adapt, implant or other derivative operations on the equipment software, and it is not allowed to study the internal implementation of the equipment in any way.

Personal safety

- ◆ Wear appropriate personal protective equipment during equipment operation. In case of any fault that may cause personal injury or equipment damage, the operation shall be terminated immediately, the person in charge shall be reported, and effective protective measures shall be taken.
- ◆ Before using the tool, please master the correct use method of the tool to avoid personal injury and equipment damage.
- ◆ When the equipment is running, the shell temperature is high and there is a risk of burns. Do not touch it.
- ◆ In case of battery failure, the temperature may exceed the burn threshold of the touchable surface, and contact should be avoided.
- ◆ Do not open or damage the battery. The released electrolyte is harmful to the skin and eyes. Avoid contact.
- ◆ Do not place irrelevant items on the top of the equipment or insert them anywhere in the equipment.
- ◆ Do not place inflammables around the equipment.
- ◆ The battery shall not be placed in the fire to avoid explosion and endanger personal safety.
- ◆ Do not place the battery module in water or other liquids.
- ◆ Do not short-circuit the battery terminal, which may cause combustion.
- ◆ The battery may cause the danger of electric shock and large short-circuit current. When using the battery, pay attention to the following precautions :
 - a) Remove watches, rings or other metal objects.
 - b) Tools using insulated handles .
 - c) Wear rubber gloves and boots .
 - d) Do not place tools or metal parts on the top of the battery .
 - e) Disconnect the charging power supply before connecting or disconnecting the battery terminal.
- ◆ Do not use water or detergent to clean the electrical parts inside and outside the cabinet.

- ◆ Do not stand or lean on or sit on the equipment.
- ◆ Do not damage each module of the equipment.
- ◆ When installing the battery module, if the battery module falls or is strongly impacted, the equipment will be damaged. It is strictly prohibited to continue to use, otherwise there will be safety risks (cell leakage, electric shock injury, etc.).

Treatment measures for battery leakage

In case of electrolyte leakage, avoid contact with leaked liquid or gas. Electrolyte is corrosive and contact may cause skin irritation and chemical burns. In case of contact with battery electrolyte, the following measures shall be taken.

Inhalation: evacuate the contaminated area, enter fresh air immediately, and seek medical help immediately.

Eye contact: immediately flush eyes with plenty of water for at least 15 minutes, do not rub, and seek medical help immediately.

Skin contact: immediately wash the contact area with plenty of water and soap and seek medical help immediately.

Ingestion: seek medical help immediately.

Fire treatment measures

- ◆ In case of fire, the system should be powered off under the condition of ensuring safety.
- ◆ Use carbon dioxide, FM-200 or ABC dry powder fire extinguisher to extinguish the fire.



When the battery temperature is too high, it will cause battery deformation, damage, electrolyte overflow and toxic gas leakage. Please keep away from it to avoid skin irritation and chemical burns.

Flood emergency measures

- ◆ Power down the system to ensure personal safety.
- ◆ If any part of the battery is flooded, do not touch the battery to avoid electric shock.
- ◆ Do not use the flooded battery. Contact the battery recycling company for scrapping.

Battery recycling

- ◆ Please dispose of waste batteries according to local laws and regulations. Do not treat batteries as domestic waste.
- ◆ If the battery leaks or bulges, please contact technical support or battery recycling company for scrapping.
- ◆ When the battery is unavailable beyond its service life, please contact the battery recycling company for scrapping.
- ◆ Avoid exposing the battery to high temperature or direct sunlight.
- ◆ Avoid exposing the battery to high humidity or corrosive environment.

1.2 Personnel requirements

- ◆ The personnel responsible for the installation and maintenance of this equipment must understand various safety precautions and master the correct operation methods.
- ◆ Only qualified professionals or trained personnel are allowed to install, operate and maintain the equipment.
- ◆ Only qualified professionals are allowed to dismantle safety facilities and overhaul equipment.
- ◆ Personnel operating the equipment, including operators, trained personnel and professionals, shall have the special operation qualification required by the local state.
- ◆ The replacement of equipment or components (including software) must be completed by professionals or authorized personnel.



Explanation

- ◆ Professionals: those who have training or experience in operating equipment and can understand the potential sources and magnitude of hazards in the process of equipment installation, operation and maintenance.
- ◆ Trained personnel: personnel who have received corresponding technical training and have necessary experience, can be aware of the risks that may be brought to him during a certain operation, and can take measures to minimize the risks to himself or other personnel.
- ◆ Operators: operators who may come into contact with the equipment other than trained personnel and professionals.

1.3 Electrical safety

General requirements



Before making electrical connection, please ensure that the equipment is not damaged, otherwise electric shock or fire may be caused.

- ◆ All electrical connections must meet the national electrical standards.
- ◆ The cable provided by the user shall meet the requirements of local laws and regulations.
- ◆ Use special insulating tools for high voltage operation.

DC operation



It is forbidden to install or remove the power line with electricity. When the power cord contacts the conductor, it will produce arc or electric spark, which can lead to fire or personal injury.

- ◆ Before the electrical connection of the equipment, if the live parts may be touched, the corresponding breaking device at the front level of the equipment must be disconnected.
- ◆ Before connecting the power cord, confirm that the label identification of the power cord is correct before connecting.

- ◆ If the equipment has multiple inputs, all inputs of the equipment shall be disconnected, and the equipment can be operated only after the equipment is completely powered off.

Wiring requirements

- ◆ The use of the cable in high temperature environment may cause aging and damage of the insulating layer. The distance between the cable and the periphery of the heating device or heat source area shall be at least 30mm.
- ◆ Similar cables shall be bound together, and different types of cables shall be laid at least 30mm apart. Mutual winding or cross laying is prohibited.
- ◆ The cables used must be firmly connected, well insulated and of appropriate specifications.

2.Product introduction

2.1 Product introduction

Function

Li-ion battery includes only battery modules, which can store and release electric energy according to the requirements of inverter management system. The input and output ports of battery are 48 / 51.2V DC.

- ◆ Battery charging: the power control module is connected with the energy storage terminals (BAT +, bat -) of the inverter to charge the battery and store the excess photovoltaic energy in the battery under the control of the inverter.
- ◆ Battery discharge: when the photovoltaic energy is insufficient to supply power to the load, the system needs to control the battery to supply power to the load and output the stored battery energy to the load through the inverter.

Technical Specification



VT-5139
Wall Mount Type

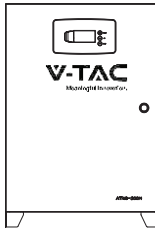

VT-12040
Stand alone Type

ID	Voltage	Capacity	IP Level	Screen
VT-5139	48V/51.2V	100Ah	IP21	LCD
VT-12040	48V/51.2V	200Ah	IP21	LCD

VT-5139 Technical Specification

Battery type	LFP
Rated capacity of battery pack	100Ah
Rated voltage of battery pack	51.2V
Maximum charging voltage	57.6V
Minimum discharge voltage	40V
Rated charge/discharge current	50A
Maximum charge/discharge current	75A
Charging temperature range	0 to +45°C
Discharge temperature range	-20°C to +50°C
Depth of discharge	>80%
Discharge magnification	<1C
Self-discharge (25°C)	<3%/Month
Cycle life	>5000 times (<0.5C)
Interactive mode (APP)	LCD+Button+Bluetooth
Dimension	638*520*190mm (±2mm)
Weight	53.0KG

VT-12040 Technical Specification

Battery type	LFP
Rated capacity of battery pack	200Ah
Rated voltage of battery pack	51.2V
Maximum charging voltage	57.6V
Minimum discharge voltage	40V
Rated charge/discharge current	100A
Maximum charge/discharge current	120A
Charging temperature range	0 to +45°C
Discharge temperature range	-20°C to +50°C
Depth of discharge	>80%
Discharge magnification	<1C
Self-discharge (25°C)	<3%/Month
Cycle life	>5000 times (<0.5C)
Interactive mode (APP)	LCD+Button+Bluetooth
Dimension	750*515*250mm (±2mm)
Weight	91.0KG

The installation methods of products are consistent, Please follow up the screen operation for details

2.2 Appearance description

VT-5139 LCD screen

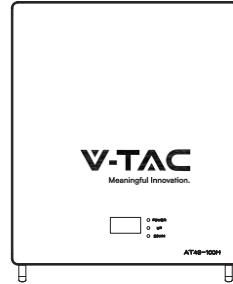

Item	Function	Remark
Button	POWER	When Powered on: 1. Short press: invalid 2. Long press (press for 4~6 seconds and release): power off When powered off: 1. Short press: invalid 2. Long press (press for 4~6 seconds and release): turn on
	UP	Page up
	DOWN	Page down
Switch	DC OUTPUT	Use the key to open the front panel before switching on and off
LCD		There are 6 display interfaces in total: 1. Main interface information (voltage/current/SOC/status code); 2. Secondary main interface information (maximum and minimum cell voltage/maximum and minimum temperature); 3. Display 1-4 cell voltage; 4. Display 5-8 cell voltage; 5. Display 9-12 cell voltage; 6. Display 13-16 cell voltage;
Error code		E11: Level 1 alarm of module equipment failure E12: Module equipment failure secondary alarm E21: Level 1 alarm of module communication abnormality E22: Module communication abnormality secondary alarm E31: Module address is abnormal level 1 alarm E32: Module Address Abnormal Level 2 Alarm E41: Module balancing abnormal level 1 alarm E42: Module balance abnormal secondary alarm E51: Module total voltage overvoltage level 1 alarm E52: Module total voltage overvoltage secondary alarm E61: Level 1 alarm of module total voltage undervoltage E62: Second-level alarm of module total voltage undervoltage E71: Module charging overcurrent level 1 alarm E72: Module charging overcurrent secondary alarm E81: Module discharge overcurrent level 1 alarm E82: Module discharge overcurrent secondary alarm E83: Module discharge load short circuit (serious) E91: Single battery overvoltage level 1 alarm E92: Single battery overvoltage secondary alarm E101: Single battery undervoltage level 1 alarm E102: Single battery undervoltage secondary alarm E111: Module battery high temperature level 1 alarm E112: Module battery high temperature secondary alarm E121: Module battery low temperature level 1 alarm E122: Module battery low temperature secondary alarm

VT-5139 Interface

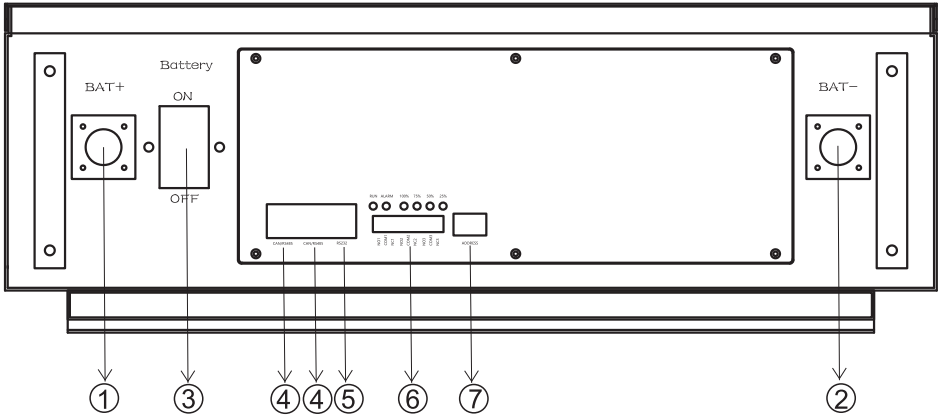

Port	Port type	NO	Signal name	Remark
1,2	Battery output interface	1	BAT+	Battery positive output interface
		2	BAT-	Battery negative output interface
3	Battery output switch	-	Battery	Battery output switch (control positive)
4	Communication Interface (RJ45)	1	CAN-H	CAN bus high level
		2	CAN-L	CAN bus low level
		3	null	null
		4	485-A	RS485-A
		5	485-B	RS485-B
		6	null	null
		7	GT1	communication place
		8	GT1	communication place
5	Communication Interface (RJ11)	1	232-RXD	232 receive signal
		2	232-TXD	232 send signal
		3	GT1	communication place
		4	GT1	communication place
		5	null	null
		6	null	null
6	Dry contact 1 (3.81 3P Phoenix Terminal)	1	NO1	Dry contact 1
		2	COM1	Dry contact 1 public Terminal
		3	NC1	Dry contact 1 normally closed Terminal
	Dry contact 2 (3.81 3P Phoenix Terminal)	1	NO2	Dry contact 2 normally open Terminal
		2	COM2	Dry contact 2 public Terminal
		3	NC2	Dry contact 2 normally closed Terminal
	Dry contact 3 (3.81 3P Phoenix Terminal)	1	NO3	Dry contact 3 normally open Terminal
		2	COM3	Dry contact 3 public Terminal
		3	NC3	Dry contact 3 normally closed Terminal
7	DIP switch	-	ADDRESS	Binary dial mode

VT-12040 LCD screen

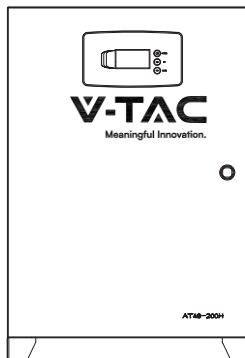
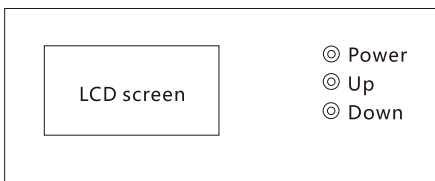

Item	Function	Remark
Button	POWER	When Powered on: 1. Short press: invalid 2. Long press (press for 4~6 seconds and release): power off When powered off: 1. Short press: invalid 2. Long press (press for 4~6 seconds and release): turn on
	UP	Page up
	DOWN	Page down
Switch	DC OUTPUT	Use the key to open the front panel before switching on and off
LCD		There are 6 display interfaces in total: 1. Main interface information (voltage/current/SOC/status code); 2. Secondary main interface information (maximum and minimum cell voltage/maximum and minimum temperature); 3. Display 1-4 cell voltage; 4. Display 5-8 cell voltage; 5. Display 9-12 cell voltage; 6. Display 13-16 cell voltage;
Error code		E11: Level 1 alarm of module equipment failure E12: Module equipment failure secondary alarm E21: Level 1 alarm of module communication abnormality E22: Module communication abnormality secondary alarm E31: Module address is abnormal level 1 alarm E32: Module Address Abnormal Level 2 Alarm E41: Module balancing abnormal level 1 alarm E42: Module balance abnormal secondary alarm E51: Module total voltage overvoltage level 1 alarm E52: Module total voltage overvoltage secondary alarm E61: Level 1 alarm of module total voltage undervoltage E62: Second-level alarm of module total voltage undervoltage E71: Module charging overcurrent level 1 alarm E72: Module charging overcurrent secondary alarm E81: Module discharge overcurrent level 1 alarm E82: Module discharge overcurrent secondary alarm E83: Module discharge load short circuit (serious) E91: Single battery overvoltage level 1 alarm E92: Single battery overvoltage secondary alarm E101: Single battery undervoltage level 1 alarm E102: Single battery undervoltage secondary alarm E111: Module battery high temperature level 1 alarm E112: Module battery high temperature secondary alarm E121: Module battery low temperature level 1 alarm E122: Module battery low temperature secondary alarm

VT-12040Interface

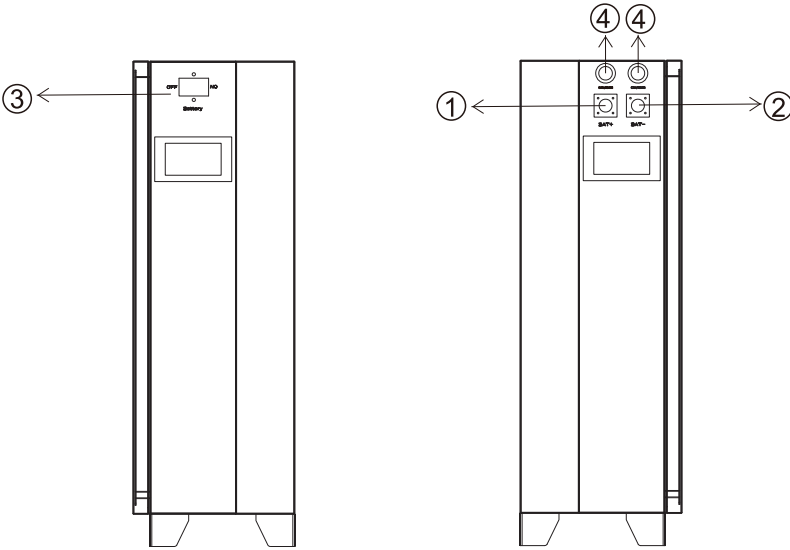

Port	Port type	NO	Signal name	Remark
1,2	Battery output interface	1	BAT+	Battery positive output interface
		2	BAT-	Battery negative output interface
3	Battery output switch	-	Battery	Battery output switch (control positive)
4	Communication Interface (RJ45)	1	CAN-H	CAN bus high level
		2	CAN-L	CAN bus low level
		3	null	null
		4	485-A	RS485-A
		5	485-B	RS485-B
		6	null	null
		7	GT1	communication place
		8	GT1	communication place

2.3 System diagram

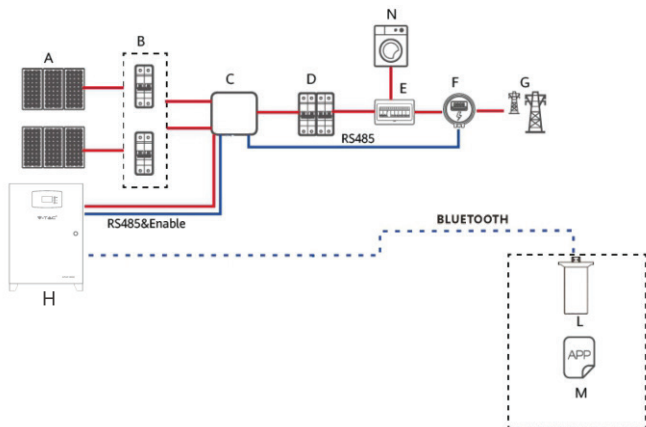

- | | | |
|---------------------------------|----------------------------|---------------------|
| (A) PV module | (B) DC switch | (C) Inverter |
| (D) AC switch | (E) Power Distribution Box | (H) Battery storage |
| (F) Intelligent power collector | (G) Power grid | (M) APP |
| (L) Bluetooth | (N) Load | |

Explanation

- ◆ The input and output of the battery energy storage system are connected to the energy storage port of the inverter.
- ◆ Following are the modes to communicate with the battery energy storage system:
 - The Inverter can be connected through CAN interface to realize the communication and control between the inverter and battery.
 - The battery can be accessed directly through the mobile phone Bluetooth app to view, manage and maintain the performance.

2.4 System Sleep and Wake Up

Sleep:

When any of the following conditions is met, the system enters the low power consumption mode:

- ◆ Press the key (3 ~ 6S) and release the key.
- ◆ The minimum monomer voltage is lower than the sleep voltage, and the duration reaches the sleep delay time (no communication, no protection, no balance and no current).

Notice

Before entering sleep, ensure that the input terminal is not connected to the external voltage, otherwise it will not be able to enter the low power consumption mode.

Wake up:

When the system is in the low power consumption mode and meets any of the following conditions, the system will exit the low power consumption mode and enter the normal operation mode:

- ◆ Connect the charger, and the output voltage of the charger shall be greater than 48V.
- ◆ Press the key (3 ~ 6S) and release the key.

3.Product installation

3.1 Unpacking inspection

Please confirm whether the outer package of the product is damaged before unpacking. After unpacking, please carefully check the product for damage or lack of accessories. In case of damage or lack of accessories, please contact the supplier directly for assistance.

VT-5139

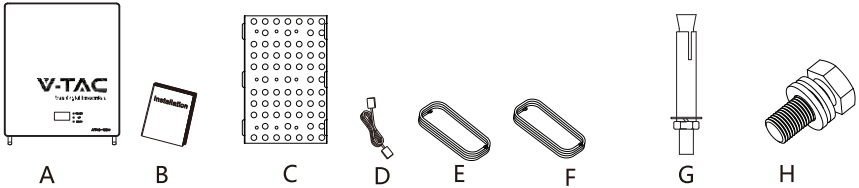

No.	Q'ty	Description
A	1	Battery pack
B	1	Instruction manual
C	1	Wall mounting bracket
D	1	BMS to inverter communication line, L=1.5 meter
E	1	16mm ² M6 to M8 power cord (Red color for positive pole, L=1.5 meter)
F	1	16mm ² M6 to M8 power cord (Black color for negative pole, L=1.5 meter)
G	6	M8X100 expansion screw
H	2	M8X16 screw to fix power cord (BMS side)

VT-12040

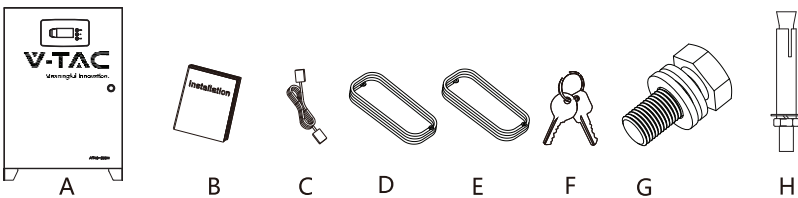

No.	Q'ty	Description
A	1	Battery pack
B	1	Instruction manual
C	1	BMS to inverter communication line, L=1.5 meter
D	1	20mm ² M6 to M8 power cord (Red color for positive pole, L=1.5 meter)
E	1	20mm ² M6 to M8 power cord (Black color for negative pole, L=1.5 meter)
F	1	Battery pack case door key
G	2	M8X16 screw to fix power cord (BMS side)
H	4	M10X100 expansion screw

3.2 Basic installation requirements

- ◆ It shall be installed in a dry and well ventilated environment to ensure good heat dissipation.
- ◆ It is recommended to choose a sheltered installation site or build a sunshade.
- ◆ Avoid direct sunlight or rain, the surrounding environment is clean, and there is no large amount of infrared radiation, organic solvents and corrosive gases. It is preferred to be indoors.



- ◆ The installation position shall be away from the fire source.
- ◆ The installation position is not accessible to children.
- ◆ The installation position shall be far away from water sources, such as faucets, sewer pipes, sprinklers, etc., to avoid water infiltration.
- ◆ The installation wall can support the weight of the battery for a long time.
- ◆ Make sure that the selected installation location matches the size of the battery.
- ◆ Do not place inflammables and explosives around the battery.
- ◆ When the battery is running, do not block the vent or cooling system to prevent high temperature fire. Battery operating temperature, charging 0-55°C, discharging -20 ~ 60 °C.
- ◆ It is forbidden to put the battery in the environment of flammable, explosive gas or smoke, and any operation in this environment is prohibited.
- ◆ The battery can be installed on a vertical or backward inclined plane. Please refer to the following figure:

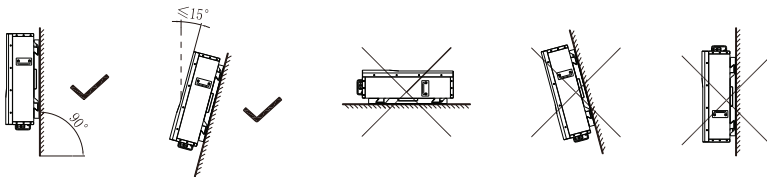

- ◆ In order to ensure good heat dissipation of the machine and convenient operation and maintenance of personnel, sufficient clearance shall be reserved for the machine during installation. The specific requirements are shown in the figure below:

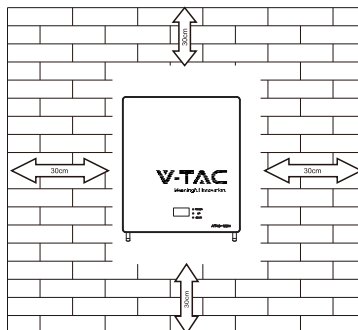

3.3 Ladder use safety

- ◆ Wooden ladder or FRP ladder shall be used when power climbing operation may be involved.
- ◆ When using the herringbone ladder, the pulling rope must be firm, and someone must hold the ladder during operation.
- ◆ Before using the ladder, please confirm that the ladder is intact, the bearing weight of the ladder meets the requirements, and overweight is strictly prohibited.
- ◆ When using the ladder, the wide foot of the ladder shall face down or protective measures shall be taken at the bottom of the ladder to prevent slipping.
- ◆ The ladder should be placed in a stable place. The gradient of the ladder should be 75°, which can be measured with an angle ruler, as shown in the figure below.



- ◆ When climbing the ladder, please pay attention to the following actions to reduce danger and ensure safety:
 - ◆ Keep your body steady.
 - ◆ The maximum height of operators standing on their feet shall not exceed the fourth step of the ladder from top to bottom.
 - ◆ Ensure that the center of gravity of the body does not deviate from the edge of the ladder.

3.4 Drilling safety

The following safety precautions shall be considered when drilling on the wall and ground:

- ◆ Wear goggles and protective gloves when drilling.
- ◆ During drilling, the equipment shall be covered to prevent debris from falling into the equipment. After drilling, the debris shall be cleaned.

3.5 Safety of handling heavy objects

- ◆ When carrying heavy objects, be prepared to bear the load to avoid being crushed or sprained by the heavy objects.

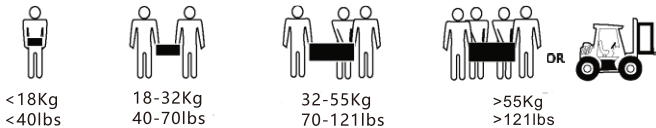

- ◆ When handling the equipment by hand, wear protective gloves to avoid injury.

3.6 Installation guidelines

- ◆ Determine the exact location of battery installation; If it is wall mounted, the wall thickness shall be greater than or equal to 100mm;
- ◆ Use the mounting bracket or cardboard to determine the specific location of the hole; Keep the top edge of the cardboard horizontal.
- ◆ Drill 6 holes at the marked position with the hole diameter of $\varnothing 8$; The hole depth shall not be less than 55mm.
- ◆ Knock 6 expansion screws into the drilled holes.
- ◆ Hang the battery mounting bracket on the screw.

- ◆ Lock the nut and fix the battery mounting bracket. Then hang the battery on the mounting bracket.
- ◆ installation is complete.

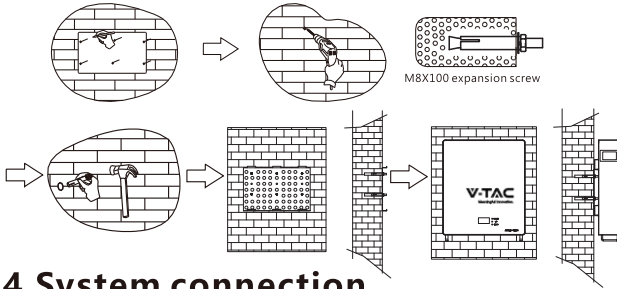

4. System connection

4.1 Communication line



PIN	BMS	Inverter
1	CANH	X
2	CANL	X
3	X	X
4	RS485_A	CANH
5	RS485_B	CANL
6	X	GND
7	GND	RS485_A
8	GND	RS485_B

- ◆ Different inverter communication protocols have different pin definitions. Please pay attention to the compatibility between the battery and inverter RS485 / can communication line.

4.2 System connection diagram

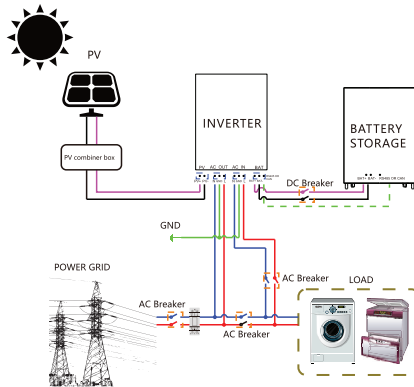

Cable color	Description	Cable color	Description
	DC positive wire		Live Wire
	DC negative wire		Naught wire
	Ground wire		Communication line

4.3 Battery connection

VT-5139
100Ah/Wall Mount Type
 Single battery connection

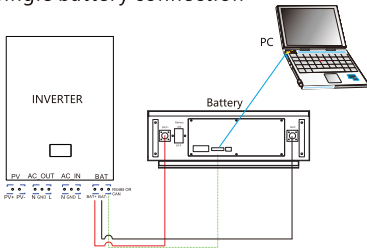

Multiple battery connection

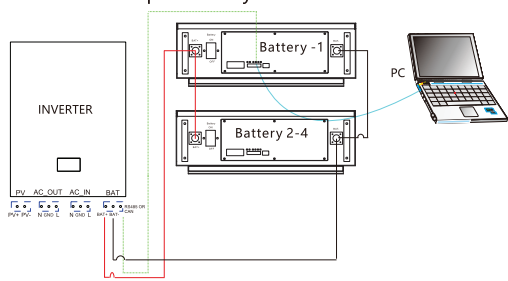

VT-12040
200Ah/Standalone Type

Single battery connection

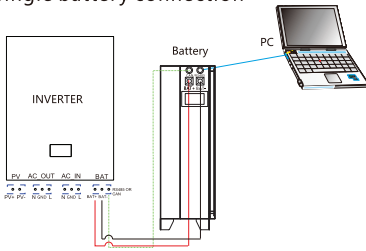

Multiple battery connection

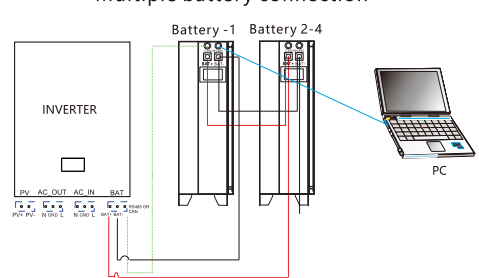

Notice

For the battery monitoring software for windows, please contact your local distributor for details if need .

Cable color	Description	Cable color	Description
	DC positive wire		Communication line
	DC negative wire		Communication line

Warning

- ◆ Batteries are not allowed to be connected in series.
- ◆ Up to 4 batteries are allowed to be connected in parallel.
- ◆ Different battery chemical systems, different batches of batteries with different design technical parameters can not be combined and used together.
- ◆ Under multiple battery connection mode, not support communication in parallel, Just need connect Battery-1's communication line, other battery (No.2-4)'s communication port is null (no connected). Select the working mode to "Li-ion" or "Lead-acid" mode in the inverter menu .

4.3 Battery connection

VT-5139
100Ah/Wall Mount Type
 Multiple battery connection

VT-12040
200Ah/Standalone Type
 Multiple battery connection

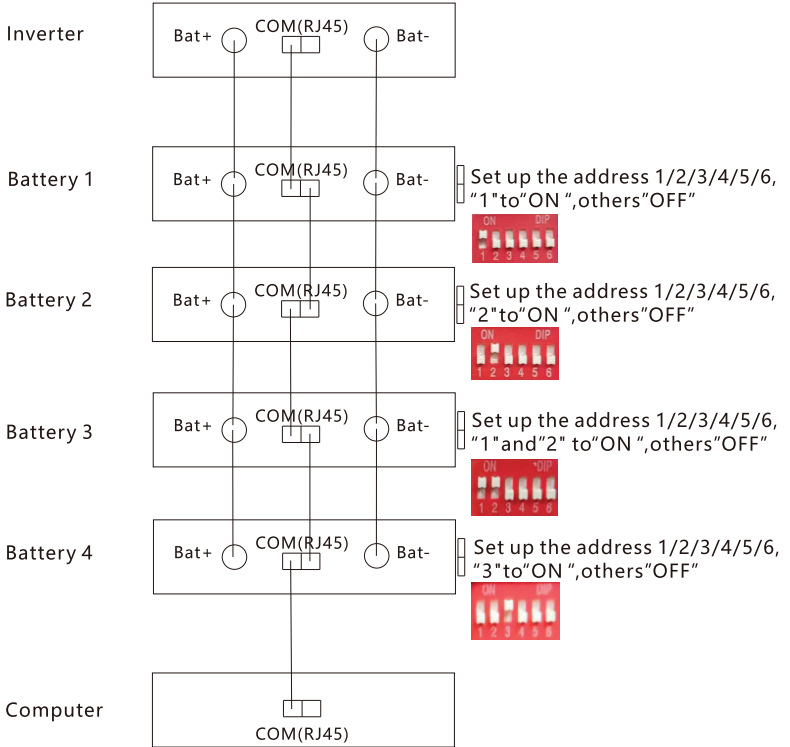

Notice

VT-5139(100Ah/Wall Mount Type) , the address switch is on the case surface
 VT-12040(200Ah/Standalone Type), the address switch is inside the case ,please set up the address before doing the battery multiple connection,please use the key to open the case door, the address switch is located as bellow:

VT-12040

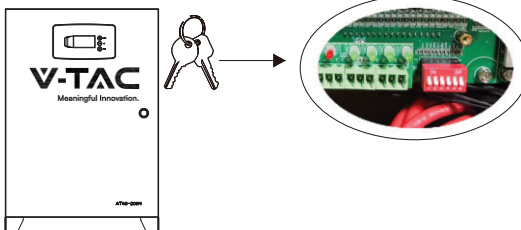

5. Indicator Description

LCD screen:there are 4 LEDS on the front panels to show the battery working status, indication as bellow :

PACK Status	Normal/Alarm/Protection	RUN	ALM	SOC indication LEDs				Remark
		●	●	●	●	●	●	
Power Off	Sleep	OFF	OFF	OFF	OFF	OFF	OFF	All off
Standby	Normal	Flash	OFF	Indication by SOC				Standby state
	Alarm	Flash	Flash					Cell low voltage
Charge	Normal	Flash	OFF	Indication by SOC				The maximum power LED flashes (flashes 2), and the overcharge alarm ALM does not flash
	Alarm	Flash	Flash					
	Over Charge protection	OFF	Flash	Indication by SOC				If there is no mains power, LED as standby Close charge
	Temperature/Over current Fault/Protection	OFF	Flash					
Discharge	Normal	Flash	OFF	Indication by SOC				Close discharge
	Alarm	Flash	Flash					
	Under Discharge Protection	OFF	OFF	Indication by SOC				Close discharge
	Temperature/Over current Short circuit/Fault/Protection	Flash	Flash					

Capacity indication :

Status		Charge				Discharge			
Capacity indicator		L4 ●	L3 ●	L2 ●	L1 ●	L4 ●	L3 ●	L2 ●	L1 ●
SOC%	0<SOC<25%	L4 ○	L3 ○	L2 ○	L1 ●	L4 ○	L3 ○	L2 ○	L1 ●
	25%=SOC<50%	L4 ○	L3 ○	L2 ●	L1 ●	L4 ○	L3 ○	L2 ●	L1 ●
	50%=SOC<75%	L4 ○	L3 ●	L2 ●	L1 ●	L4 ○	L3 ●	L2 ●	L1 ●
	75%=SOC=100%	L4 ●	L3 ●	L2 ●	L1 ●	L4 ●	L3 ●	L2 ●	L1 ●

LED flashing indication :

Flashing mode	● ON	○ OFF
Flash	1.0S	1.0S

6. Bluetooth App interface and operation steps

Step 1: Scan the given QR code to download App then install the app.

Step 2: After the installation is complete, open the phone settings - application settings - authorization management, and authorize the Bluetooth and positioning of this APP.

For Android



For iOS



Step 3: Open the software and click "BLE" to connect to Bluetooth

Step 4: click "Scan Devices" to scan the BLE machine, find the device starting with "AT" and Click "connect" to connect.

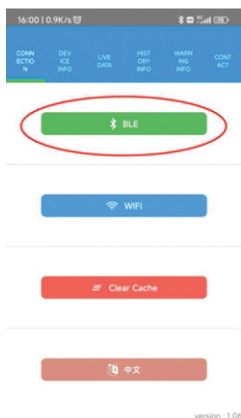

Step 5: After successfully pairing the device with the app, you can start reading the relevant data, including "CONNECTION, DEVICE INFO, LIVE DATA, HISTORY INFO, WARNING INFO, CONTACT" to switch (See the below pic).

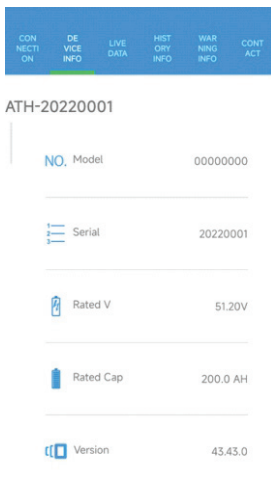

7. Maintenance and replacement

- ◆ Please maintain the equipment when you are familiar with and understand the contents of this manual and have appropriate tools and test devices.
- ◆ Before carrying out maintenance work, please power down the equipment first, then follow the instructions of the delayed discharge label and wait for the corresponding time to ensure that the equipment has been powered down before operating the equipment.
- ◆ During maintenance, please try to avoid irrelevant personnel entering the maintenance site, and temporary warning signs or fences must be erected for isolation.
- ◆ If the equipment fails, please contact your dealer in time.
- ◆ The equipment can be powered on again only after the fault is handled, otherwise it may cause fault expansion or equipment damage.
- ◆ Do not open the cover plate without authorization, otherwise there will be a risk of electric shock, and the resulting failure does not belong to the scope of warranty.
- ◆ Operation and maintenance personnel and professional technicians shall be fully trained in safe use and equipment maintenance, and shall operate with sufficient preventive measures and personal protective equipment.
- ◆ Battery maintenance shall be performed or supervised by personnel familiar with the battery and its required precautions.
- ◆ After the maintenance operation, check immediately to ensure that no tools or other parts are missing in the equipment.

8. Battery storage requirements

- ◆ When the battery is stored, it shall be placed correctly according to the identification of the packing box, and shall not be placed upside down or on the side.
- ◆ When the battery packing box is stacked, it shall meet the stacking requirements on the outer package.
- ◆ The battery shall be handled with care, and it is strictly prohibited to damage the battery.
- ◆ Storage environment requirements:
 - a. Ambient temperature: - 10 °C ~ 55 °C, recommended storage temperature: 20 °C ~ 30 °C.
 - b. Relative humidity: 35% RH ~ 85% RH.
 - c. Dry, ventilated and clean.
 - d. Avoid contact with corrosive organic solvents, gases and other substances.
 - e. Avoid direct sunlight.
 - f. The distance from the heat source shall not be less than two meters.
- ◆ When the battery is stored, it must be disconnected from the outside. If there is an indicator on the battery panel, the indicator should be off.
- ◆ The warehouse keeper shall count the battery storage every month and regularly report the battery inventory to the planning link. For batteries with storage time close to - 20 ~ 25 °C = 6 months and - 20 ~ 45 °C = 1 month, replenishment shall be arranged in time. The battery shall be charged once every three months (under the normal storage environment, long-term storage will lead to capacity attenuation and cycle life decline. If it exceeds the storage environment requirements, it will further aggravate the capacity attenuation and cycle life decline.)
- ◆ When the stored batteries are shipped, the principle of first in first out shall be followed.
- ◆ Battery maintenance shall be performed or supervised by personnel familiar with the battery and its required precautions.
- ◆ After the battery production test is completed, it needs to be supplemented to 30-50% SOC at least before storage.